



洲光源
CHAULIGHT

产品规格书 SPECIFICATION

客户名称: _____

Customer Name

产品类型: 红外接收三极管

Product Name

产品型号: ZPT034B

Part No.

<input type="checkbox"/> 技术参考 Technical Reference		<input type="checkbox"/> 样品 Sample		<input type="checkbox"/> 量产供货 Mass Product	
客户审核 (加盖公章) Client approval (Stamp)			洲光源审核 Chaulight approval		
核准 Approval	确认 Checked	核准 Approval	确认 Checked	制作 Edited	
		郝三强	李兆海	付世雄	
<input type="checkbox"/> 接收 Qualified		<input type="checkbox"/> 不接收 Disqualified		日期 Date: 2021-1-4	

联系电话(Tel): 0760-88504720

传真(Fax): 0760-88504721

地址(Add): 广东省中山市东升镇联胜南路 3 号洲光源科技园

No.3,Lian Sheng South Road ,Dong Sheng Town,Zhongshan City,Guang Dong Province.

本规格书仅用于双方交流用需经双方签订后方可生效,自签订后有效期为两年,期满后需以书面形式续签。最终解释权为洲光源所有。

This product specification is only used for technical communication.Only after the signature or seal, the specifications have the force of law.since the signing of the validity period of two years, after the expiration of the written renewal. The final interpretation right is owned by the CHAULIGHT.

广东洲光源红外半导体有限公司
Guangdong Chaulight Infrared Semiconductor Co.,Ltd.

ZPT034B 是一种高速、高灵敏度的 NPN 硅光电晶体管，在标准的 $\phi 3$ 毫米封装中成型。由于其黑色环氧，该装置对可见光和近红外辐射敏感。
The ZPT034B is a high speed and high sensitive NPN silicon phototransistor molded in a standard $\phi 3$ mm package. Due to its black epoxy the device is sensitive to visible and near infrared radiation.



特性 Feature

--感应速度快、感光度强
Fast response time、High photo sensitivity
--无铅材料、RoHS 认证
Pb.Free、RoHS compliant version

应用 Application

--红外应用系统、光电开关、复印机、扫描仪、洗衣机
Infrared applied system、Optoelectronic switch、Copiers、Scanners、Amusement machines

最大额定值 Absolute Maximum Ratings

测试项目 Parameter (Ta=25°C)	符合 Symbol	范围 Ratings	单位 Unit
最大功率 Power Dissipation *1	Pd	75	mW
集电极-发射极电压 Collector-Emitter Voltage	V _{CEO}	30	V
发射极-集电极电压 Emitter-Collector Voltage	V _{ECO}	5	V
集电极电流 Collector Current	I _{C(ON)}	20	mA
工作温度 Operating Temperature	Topr	-25~+85	°C
储存温度 Storage Temperature	Tstg	-40~+100	°C
焊接温度 Lead Soldering Temperature*2	Tsol	260	°C

*1、在 25 摄氏度的环境中测试 below 25 Free Air Temperature

*2、离胶体 2mm 以上焊接 5s 内 2mm form body for 5 seconds

产品尺寸 Package Dimension

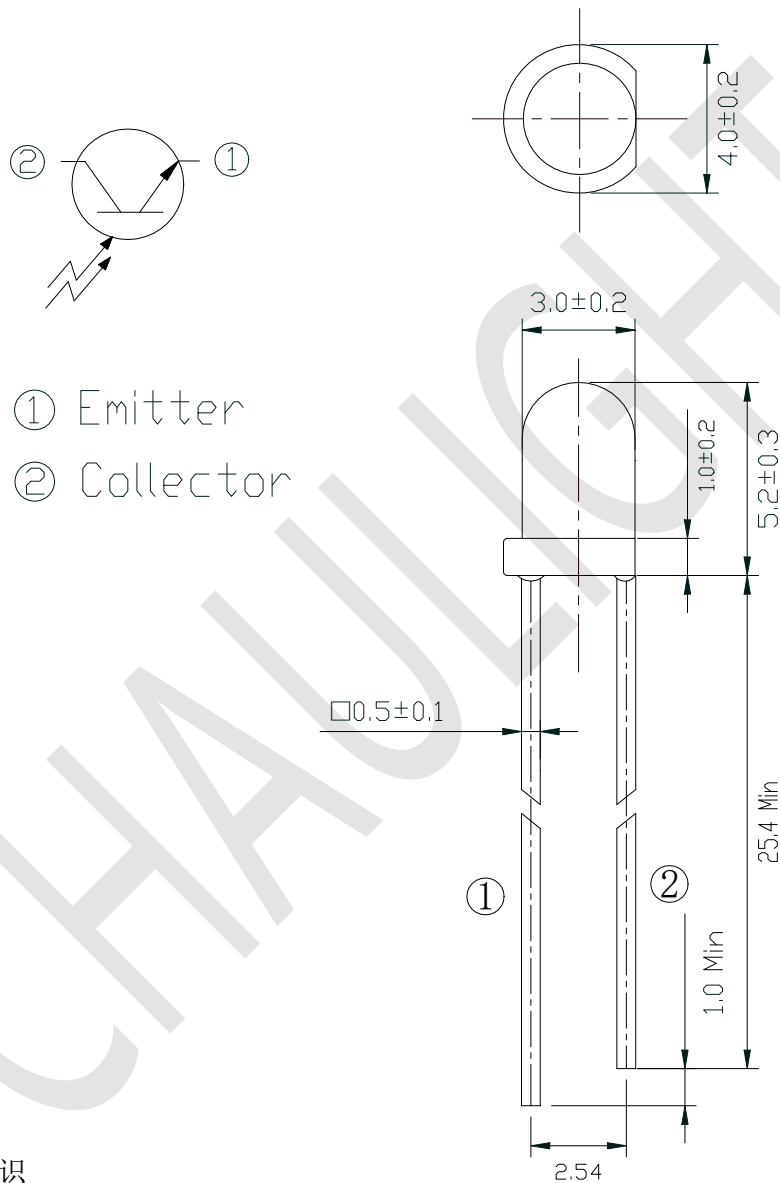

备注 Notes:

--所有尺寸为毫米标识

All dimensions are in millimeters

--未标识尺寸正负公差为 0.3mm

Tolerances unless dimensions ± 0.3 mm

光电特性 Electro-Optical Characteristics

电性参数 (温度=25℃) Parameter (Ta=25℃)	符号 Symbol	条件 Condition	最小值 Min.	典型值 Typ.	最大值 Max.	单位 Units
集电极-发射极的击穿电压 Collector-Emitter Breakdown Voltage	BV_{CEO}	$I_C=100\mu A$ $E_e=0mW/cm^2$	30	--	--	V
发射极-集电极的击穿电压 Emitter-Collector Breakdown Voltage	BV_{ECO}	$I_C=100\mu A$ $E_e=0mW/cm^2$	5	--	--	V
集电极-发射极的工作电压 Collector-Emitter Saturation Voltage	$V_{CE(sat)}$	$I_C=2mA$ $E_e=1mW/cm^2$	--	--	0.4	V
上升时间 Rise Time	t_r	$V_{CE}=5V$ $I_C=1mA$	--	15	--	μS
下降时间 Fall Time	t_f	$R_L=1000\Omega$	--	15	--	
集电极暗电流 Collector Dark Current	I_{CEO}	$E_e=0mW/cm^2$ $V_{CE}=20V$	--	--	100	nA
集电极电流 On State Collector Current	$I_{C(ON)}$	$E_e=1mW/cm^2$ $V_{CE}=5V$	0.95	--	4.85	mA
感应波长范围 Rang of Spectral Bandwidth	$\lambda_{0.5}$	--	760	--	1100	nm
峰值感应波长 Wavelength of Peak Sensitivity	λ_p	--	--	940	--	nm

等级档位 Rank

档位 Bin	符号 Symbol	条件 Condition	最小值 Min.	最大值 Max.	单位 Unit
G	$I_{C(ON)}$	$E_e=1mW/cm^2$ $V_{CE}=5V$	0.95	1.6	mA
H	$I_{C(ON)}$	$E_e=1mW/cm^2$ $V_{CE}=5V$	1.45	2.25	mA
J	$I_{C(ON)}$	$E_e=1mW/cm^2$ $V_{CE}=5V$	2.1	3.2	mA
K	$I_{C(ON)}$	$E_e=1mW/cm^2$ $V_{CE}=5V$	3.1	4.85	mA

典型光电特性曲线图 Typical Electro-Optical Characteristics Curves

集电极功率与环境温度的关系

Collector Power Dissipation vs. Ambient Temperature

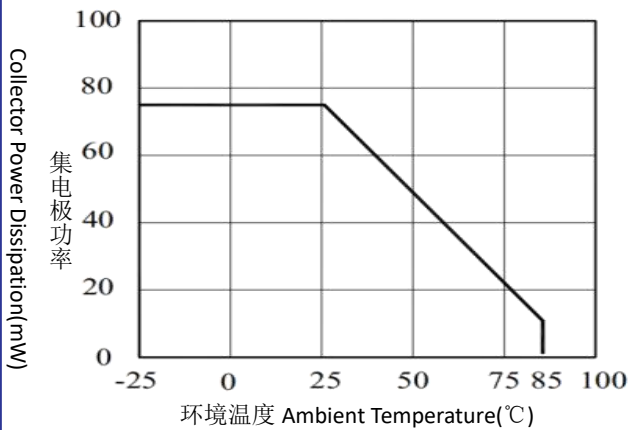

相对集电极电流与环境温度的关系

Relative Collector Current vs. Ambient Temperature

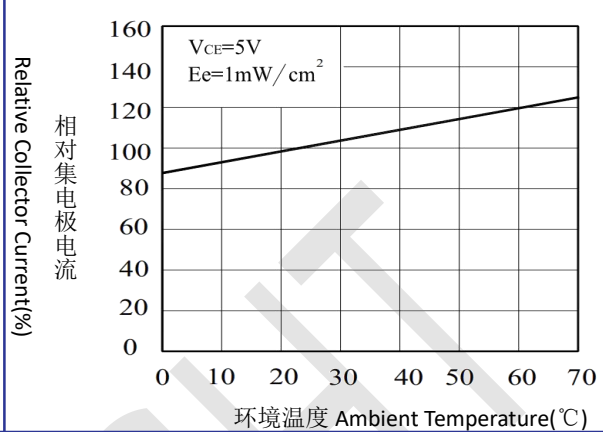

集电极暗电流与环境温度的关系

Collector Dark Current vs. Ambient Temperature

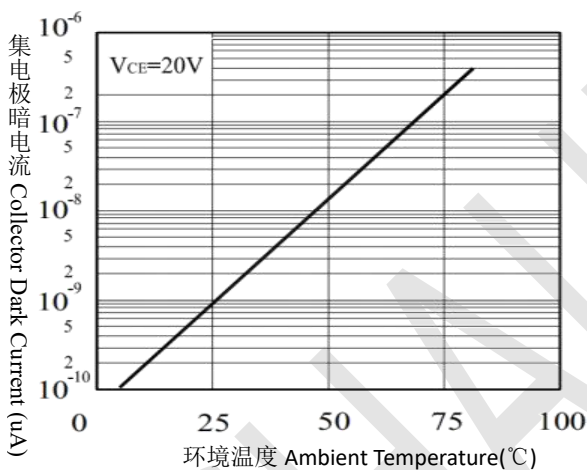

感应波长曲线图

Spectral Sensitivity

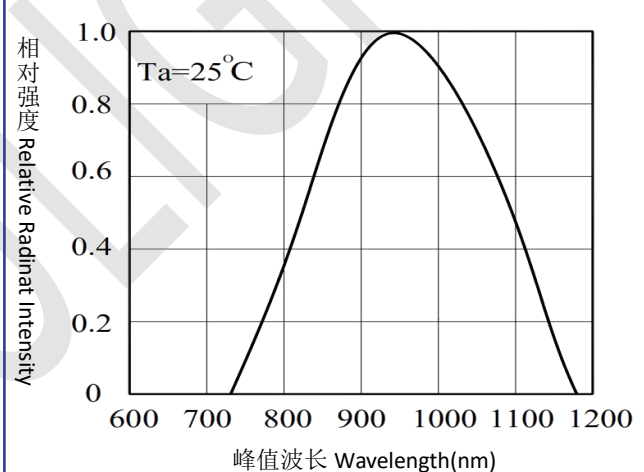

集电极电流与辐射强度的关系

Collector Current vs. Irradiance

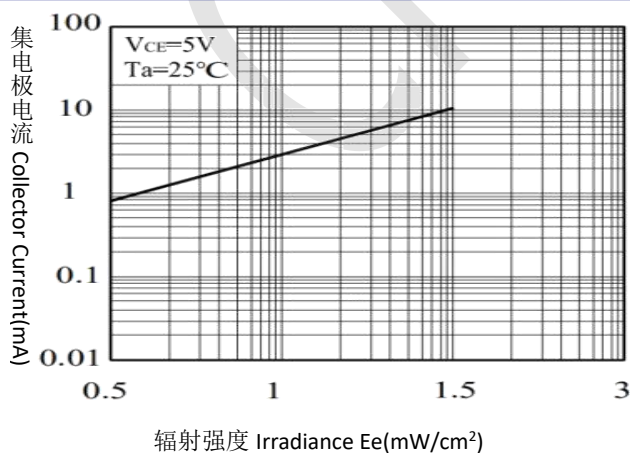

集电极电流与集电极-发射极电压的关系

Collector Current vs. Collector-Emitter Voltage

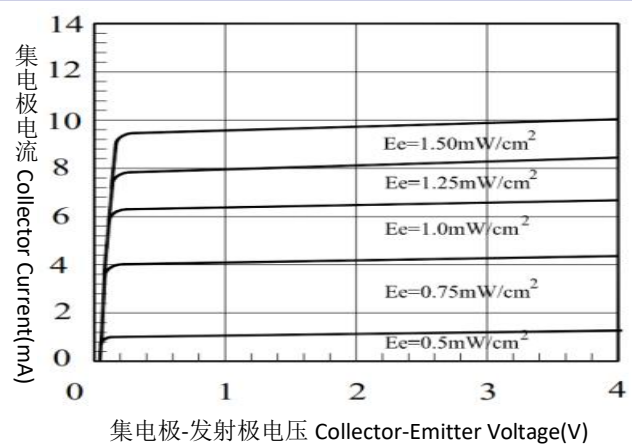

包装规格 Packing Specification

防静电袋 Anti-electrostatic bag

内包装盒 Inner Carton

外箱 Outside Carton

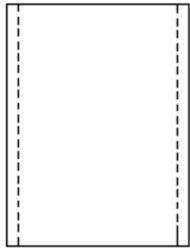

1000 只/袋
1000pcs/bag

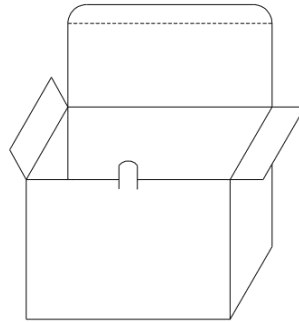

4 袋/盒
4bags/Inner Carton

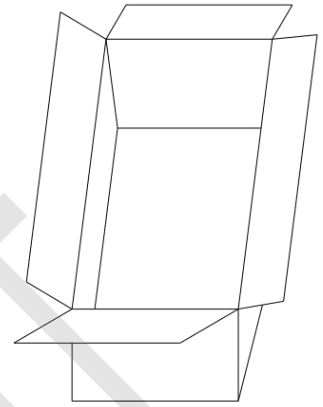

10 盒/箱
10 Inner Cartons/Outside Carton

注意事项 Note

--支架成型 Lead Forming

- 1、引线成型需在焊接前完成。Lead shaping needs to be done before welding.
- 2、不能以靠近环氧体的支架根部为支点成型。Can not be formed at the base of the support near the epoxy.
- 3、成型位置应离环氧本体 5mm 以上，特殊情况需在 5mm 以下，（但应 $\geq 2\text{mm}$ ）成型的，应制作特制的 夹具，成型时固定住靠近环氧体的管脚部位，尽管减少对环氧体的作用应力，防止因应力过大造成产 品开路及其环氧体裂损。Forming position should be above 5 mm from epoxy body, special case should be below 5 mm (but $\geq 2\text{ mm}$) molded, A special fixture shall be made to hold the pin close to the epoxy during molding, although reducing the stress on the epoxy, Prevent product opening and epoxy cracking due to excessive stress.

--储存 Storage

- 1、该产品出厂后贮存的条件应为 $0\sim 30^{\circ}\text{C}$ 、相对湿度不大于 70%，贮存期限为 3 个月。若贮存超过 3 个月，则应放在带有氮气和干燥剂的密闭容器内，贮存时间可达一年。The storage conditions of the product after leaving the factory shall be $0\sim 30^{\circ}\text{C}$, the relative humidity shall not be greater than 70%, and the storage period shall be 3 months. If stored for more than 3 months, it should be placed in a sealed container with nitrogen and desiccant for up to one year.
- 2、拆袋使用，应尽可能短时间内用完，若用不完，应满足贮存条件应为 $0\sim 30^{\circ}\text{C}$ 。相对湿度不大于 60%，并在 2 天内安装完。产品支架是铁合金表面上镀银，银表面会受到腐蚀性气体等环境的影响，应避免使产品处于易腐蚀或失去光泽的环境中，这会导致产品焊接困难。Use of bag removal, should be used as short as possible, if not used, should meet the storage conditions should be $0\sim 30^{\circ}\text{C}$. The relative humidity is not more than 60% and is installed in 2 days. The product support is silver plated on the surface of ferroalloy, the silver surface will be affected by corrosive gas and other environment, should avoid making the product in the environment of easy corrosion or loss of luster, which will lead to difficult welding of the product.

--安装 Installation

- 1、产品安装在 PCB 上，不能造成对引线施加压力。A product installed on a PCB can not cause pressure on the lead.
- 2、建议 LED 使用时，需串电阻作业，以防止大电流或大电压烧损芯片，有部分客户投诉亮度不均及色泽不均，均为大电流或大电压烧损所致。A series of resistance operations are recommended LED use to prevent high current or high voltage from burning the chip. Some customers complain that the brightness is uneven and the color is uneven.
- 3、LED 在剪脚时建议采用自动机台进行剪脚，且保持刀片锋利，以防止 扭距应力拉扯胶体与支架，产生应力破坏 LED 内部结构。LED it is recommended to use automatic machine to cut the feet, and keep the blade peak profit, so as to prevent torsion stress pulling colloid and support, resulting in stress damage LED internal structure.
- 4、建议 LED 成形加工时在焊锡前，如在焊锡后立即进行加工，此时 LED 胶体内部还存在一定的温度，若用手碰触或外力碰触到胶体，因胶体特性会产生应力拉扯断第二焊点。LED it is suggested that there is a certain temperature inside the colloid when it is processed before the solder, if it is processed immediately after the solder, if the colloid is touched by hand or by external force, the second spot will be broken due to the colloidal characteristics.
- 5、支架成形形状需要与 PCB 上的间距一致，以防止 LED 在插在 PCB 上有拉扯的状况。The shape of the bracket needs to be aligned with the spacing on the PCB to prevent LED from pulling on the insert.
- 6、LED 在折脚加工时，建议固定 LED PIN 脚后进行加工，以防止应力的产生。LED in folding foot processing, it is recommended to fix LED PIN foot after processing to prevent stress generation .
- 7、需离胶体 2 毫米才能折弯支架。2 mm from colloid to bend support.
- 8、折脚方式如下 The foot folding method is as follows:

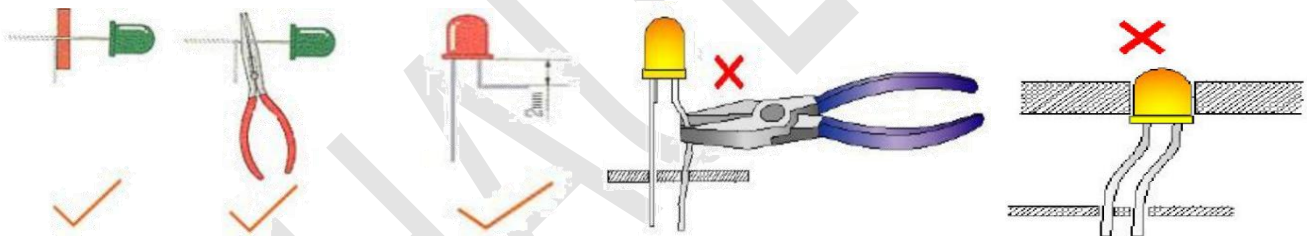
**--焊接 Soldering**

- 1、胶体不可侵入锡槽内。Epoxy non-invasive tin tank.
 - 2、加热过程中不能对引脚施加压力。Pin pressure can not be applied during heating.
 - 3、推荐焊接条件 260℃ <5s 或 340℃ <3s Recommended welding conditions 260℃ <5 s or 340℃ <3 s.
- 注：建议客户尽量使用较低的温度和较短的时间进行焊接；在符合以上推荐回流曲线条件下的死灯上 限为 500PPM. Note: Customers are advised to use lower temperature and shorter time for welding as far as possible; the upper limit of dead lamp under the condition of PPM. above recommended reflux curve is 500.
- 4、LED 无铅焊锡波峰焊条件（焊锡位置距胶体距离最小为 3mm），LED 不支持 REFLOW 焊锡，LED 避免在高温下碰触其胶体与 PIN 脚，以防止应力拉扯 断第二焊点。LED lead-free solder wave soldering condition (solder position distance from colloid minimum 3 mm), LED do not support REFLOW solder, avoid touching its colloid with PIN foot at high temperature to prevent stress pulling break the second solder joint.
 - 5、建议客户在经波峰焊后加装风扇，以利散热，需等 LED 冷却后（最好为室温后），再进行下一工序 加工。

Customers are advised to install fan after wave peak welding to facilitate heat dissipation, need to wait for LED cooling (preferably after room temperature) before the next process processing.

推荐波峰焊曲线 The wave peak welding curve is recommended:

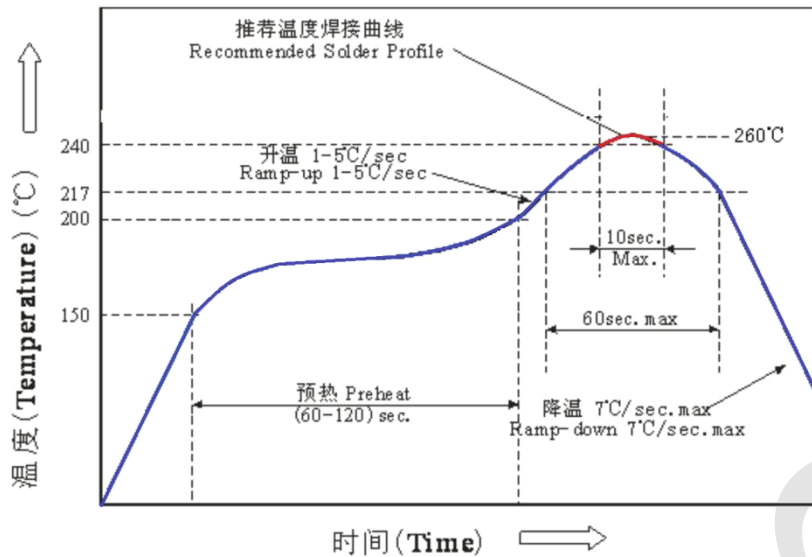

--清洗 Cleaning

- 1、在任何情况下，清洗时间应在常温 1 分钟之内进行。In any case, the cleaning time should be within 1 minute of normal temperature.
- 2、清洗产品时推荐使用酒精作为清洗剂，如使用其他清洗剂，需先确认清洗剂是否会腐蚀环氧体。氟利昂不能作为清洗剂。It is recommended to use alcohol as cleaning agent when cleaning products. If other cleaning agents are used, it is necessary to confirm whether the cleaning agent will corrode the epoxy body first. Freon can't be a cleaning agent.
- 3、不可用水清洗，以免腐蚀引线，建议使用酒精。Do not wash with water to avoid corrosion of leads, alcohol is recommended
- 4、用超声波清洗产品时，超声波功率和时间分别小于 300W 和 30 秒；PCB 和产品不能接触振荡器，不能使 PCB 上的产品产生共振。When cleaning the product with ultrasonic, the ultrasonic power and time are less than 300 W and 30 seconds, respectively; PCB and products can not contact the oscillator, can not make the product on the PCB resonance.
- 5、本型号为静电敏感器件，所以静电和电泳会损坏产品，要求使用时佩戴防静电手环，所有的装置、设备、机器、桌子、地面都必须防静电接地。This model is electrostatic sensitive device, so electrostatic and electrophoretic will damage the product, it is required to wear anti-static bracelet when all devices, equipment, machines, tables, ground must be anti-static grounding.

--其他 Other

- 1、以上规格可更改，恕不另行通知。洲光源将为上述规格的材料变更保留权力 Above specification may be changed without notice. CHAU LIGHT will reserve authority on material change for above specification.
- 2、当使用此产品时，请观察这些规格表中概述的绝对最大额定值和使用说明。洲光源不承担任何损坏结果的责任从不符合绝对最大额定值的产品的使用和这些规格表中包含的说明 When using this product, please observe the absolute maximum ratings and the instruction for using outlined in these specification sheets. CHAU LIGHT assumes no responsibility for any damage resulting from use of the product which does not comply with the

absolute maximum ratings and the instructions included in these specification sheets.

3、此规格书版权属广东洲光源红外半导体有限公司。未经允许不得转载或复印。These specification sheets include materials protected under copyright of CHAU LIGHT corporation. Please don't reproduce or cause anyone to reproduce them without CHAU LIGHT 's consent.

更改记录表 Engineering Change Notice-Record

版本 Edition	更改日期 Date	主要更改内容 Main Content	拟制 Prepared	确认 Checked
1.1	2021-1-4	新版本发布 New Edition	李兆海	郝三强